

Mechanical Data

Package 3D Photo

- Weight: 194.0000 grams (Approximate)
- Halogen Free Available Upon Request By Adding Suffix "-HF"
- Lead Free Finish/RoHS Compliant (Note1) ("P" Suffix Designates RoHS Compliant. See Ordering Information)

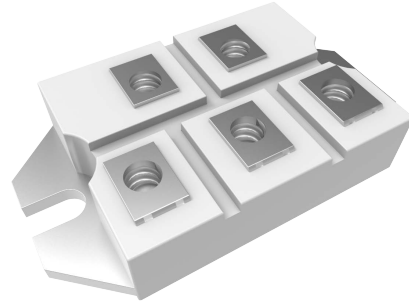

Note: 1. High Temperature Solder Exemption Applied, see EU Directive Annex 7a.

Package Outline Dimensions

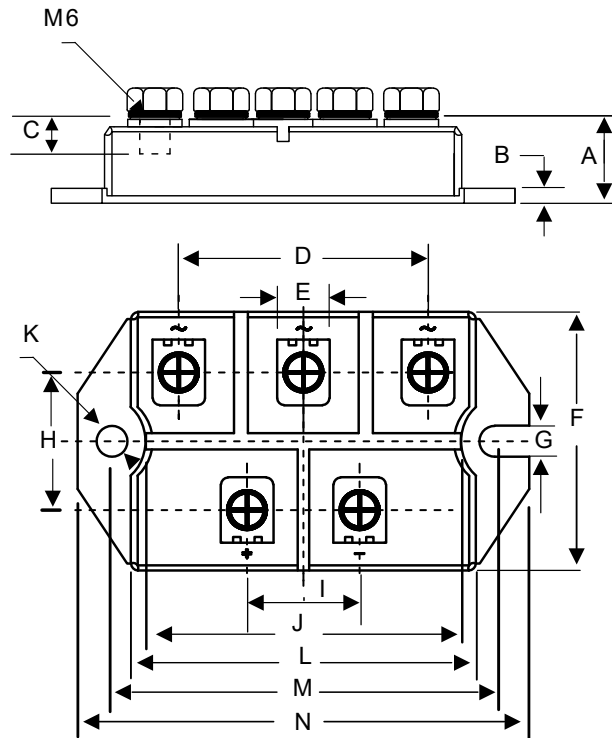

DIMENSIONS					
DIM	INCHES		MM		NOTE
	MIN	MAX	MIN	MAX	
A	0.650	0.689	16.50	17.50	
B	0.098	0.138	2.50	3.50	
C	0.256	0.295	6.50	7.50	
D	2.028	2.067	51.50	52.50	
E	0.453	0.492	11.50	12.50	
F	2.106	2.146	53.50	54.50	
G	0.236	0.276	6.00	7.00	
H	1.043	1.083	26.50	27.50	
I	0.965	1.004	24.50	25.50	
J	2.579	2.618	65.50	66.50	
K	0.256		6.50		Φ
L	2.815	2.854	71.50	72.50	
M	3.130	3.169	79.50	80.50	
N	3.681	3.720	93.50	94.50	

Packing Quantity

Package	Package Type	Minimum Packing Quantity	Carton Quantity
M5	Box	6	60

Note 1: These are minimum package quantities only. Minimum orders will differ. Contact the factory for more information on minimum order quantities.

Dimensions

Inbox Size



Description	Dimension	Specification(mm typical)
Length	L	302
Width	W	268
Height	H	53

Carton Size

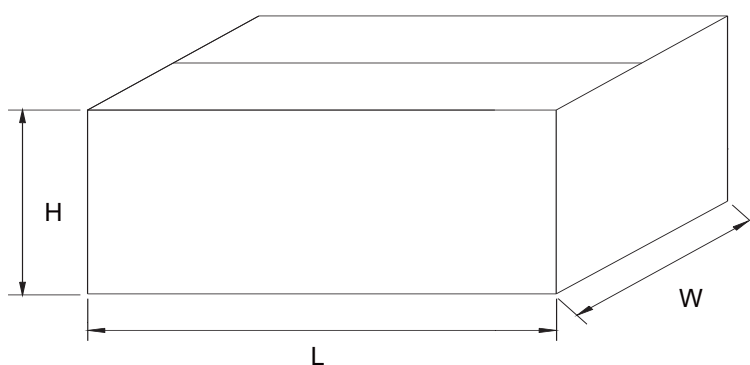

Description	Dimension	Specification(mm typical)
Length	L	555
Width	W	310
Height	H	280