

### Packing Quantity and Device Tape Orientation

Package	Tape Width	Reel Size	Pitch	Packaging Quantity			ESD/MBB Bag	Pin1 Position	Tape Orientation	OPN Suffix
				Reel	Inner Box	Carton				
				mm	inch	mm			kpcs	
SOT-23	8	7	4	3	30	120	NA	Q3		-TP
				10	160	NO	Q3		-13P	
	13	4	10	20	100	YES	Q3		-13P	

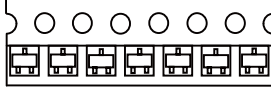
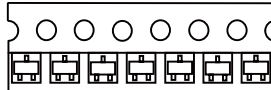
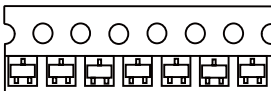

Note 1: All MOSFETs and other MSL3 products come with an ESD/MBB bag.

Note 2: These are minimum package quantities only. Minimum order quantities may vary. Please contact your sales representative for more information on minimum order quantities.

Note 3: MCC Tape&reel products meets EIA-481 specification.

Note 4: Please refer to the product datasheet for MSL level, RoHS and Halogen-Free compliance.

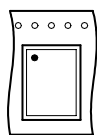
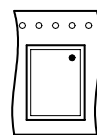
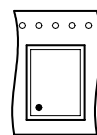
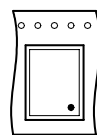
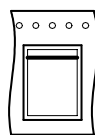
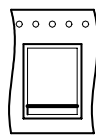
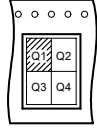
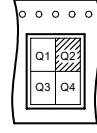
Note 5: Orientation guide for commonly used devices.

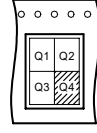
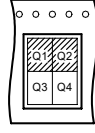
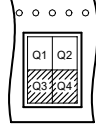
Pin1 Position	Q1	Q2	Q3	Q4	Q1Q2	Q3Q4
Orientation in Carrier						
Termination 1 Orientation by Quadrant						

## Embossed Carrier Tape Specifications

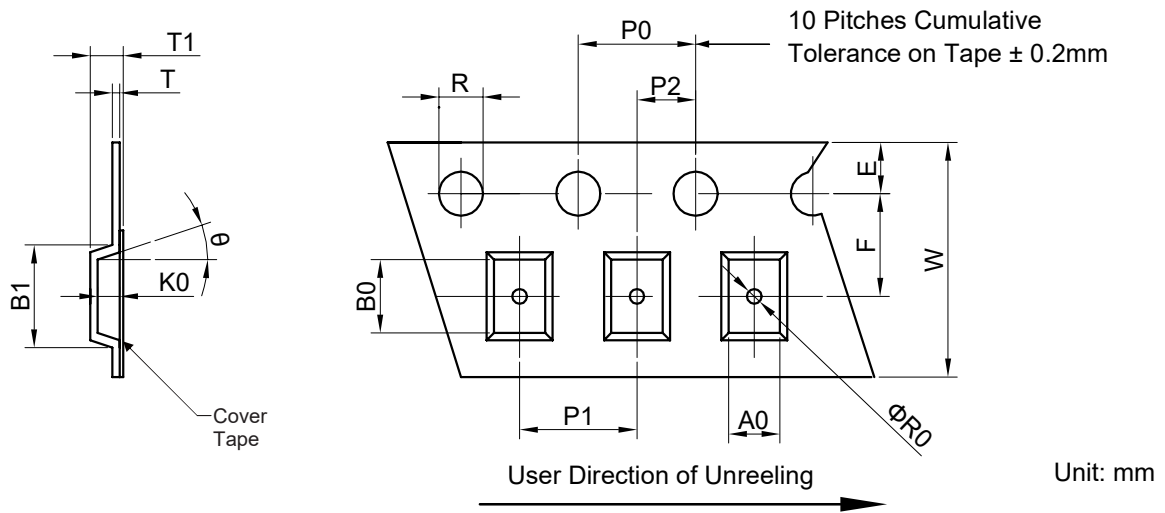

Tape Width	A0	B0	K0	B1	E	F	P0
8mm	See Note 6	See Note 6	See Note 6	See Note 7	1.75	3.5	4.0
(Tolerance)					$\pm 0.1$	$\pm 0.05$	$\pm 0.1$

Tape Width	P1	P2	R	R0	T	T1	W
8mm	4.0	2.0	1.5	1.0	0.6	2.4	8.0
(Tolerance)	$\pm 0.1$	$\pm 0.05$	$+0.1/-0$	$\pm 0.1$	Max	Max	$\pm 0.3$

Note 6: A0, B0, and K0 are determined by component size. The clearance between the components and the cavity must be within 0.05 mm min to 0.50mm max.

Note 7: For machine reference only including draft and radii concentric around B0.

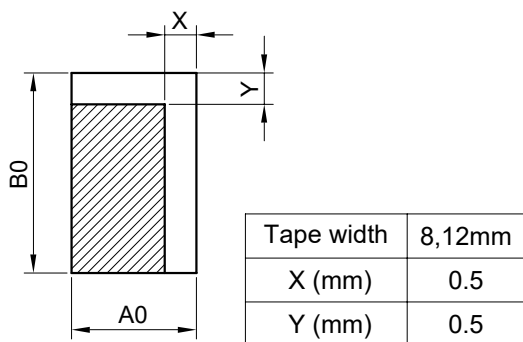

Maximum Lateral movement

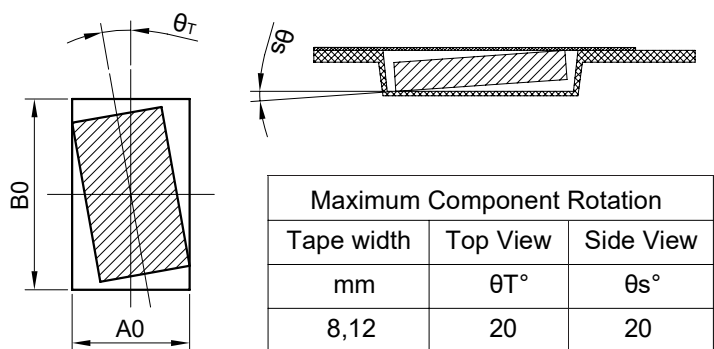

Maximum Component Rotation

## Embossed Carrier Tape Specifications



Tape Size	R Min.
8mm	25mm

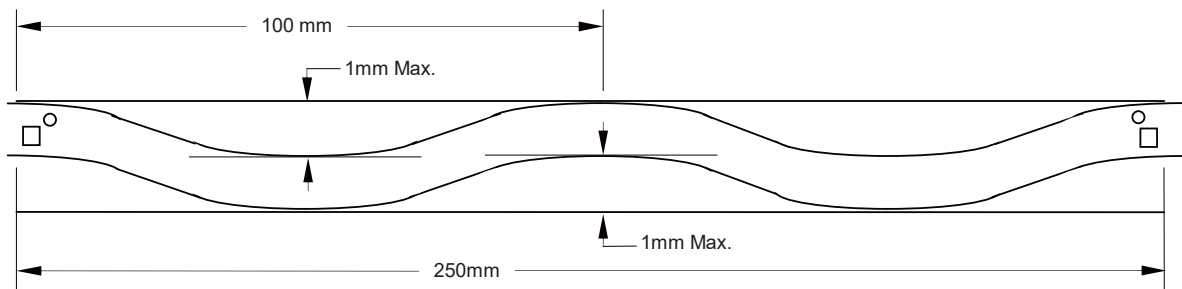

Camber (Top View)

Allowable camber to be 1mm/100mm non-accumulative over 250mm

## Start and Finish Specification

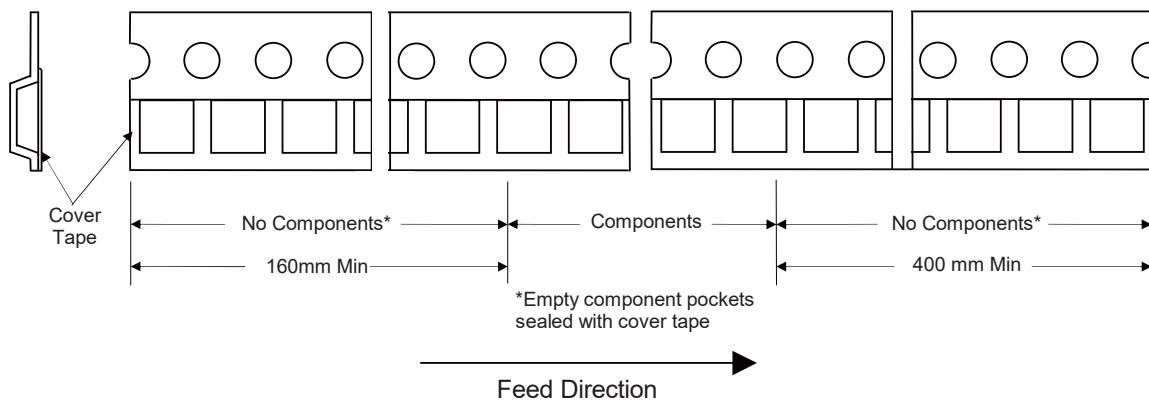

## Surface Mount Reel Specifications

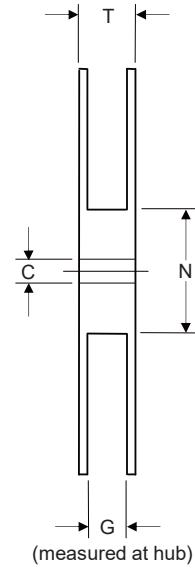
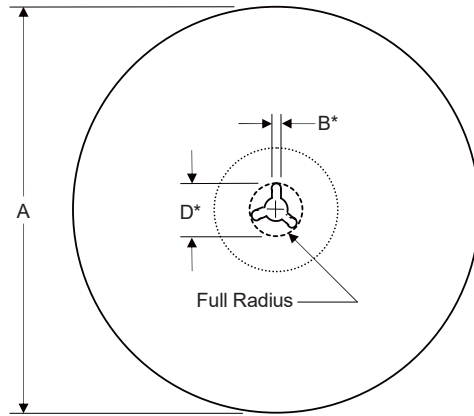

\* Drive spoke dimensions optional. If drive spoke is used then asterisked dimensions apply.

Tape Width	A	B	C	D	N	G	T
8mm	180/335	1.5	13.0	20.2	55/100	8.4	14.4
(Tolerance)	Max	Min	±0.2	Min	±5.0	+1.5	Max

## Dimensions

### Inbox Size

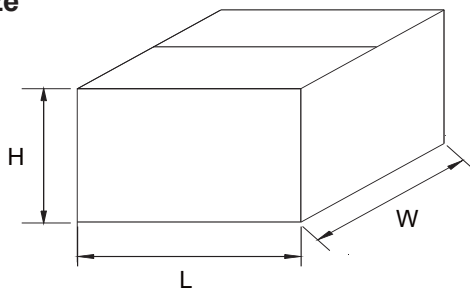

Dimension	Specification(mm typical)			
	General		ESD/MBB Bag	
Reel Size	7 inch	13 inch	7 inch	13 inch
L	187	342	245	370
W	130	342	145	340
H	187	22	202	55

### Carton Size

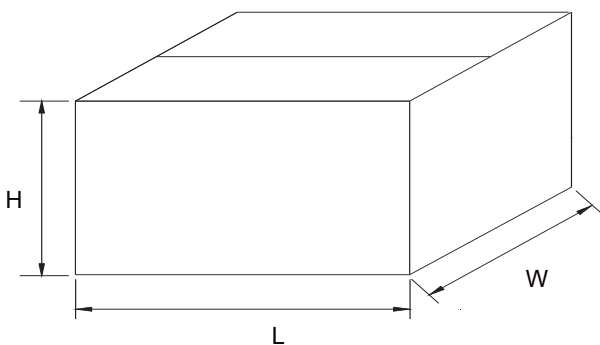

Dimension	Specification(mm typical)			
	General		ESD/MBB Bag	
Reel Size	7 inch	13 inch	7 inch	13 inch
L	390	395	510	385
W	275	360	305	365
H	207	366	235	315